

Filtro a Circolazione 'TURBOVORTEX' (Circulating Screen Filter 'TURBOVORTEX')

Il filtro a circolazione viene impiegato per filtrare acqua proveniente da pozzo, lago, fiume, etc. con piccole e medie particelle inorganiche in sospensione. In presenza di una notevole quantità di sabbia in sospensione è consigliabile usare prima il separatore di sabbia.

(The circulating screen filter is suitable to filter water from a well, lake, river, etc. with small and medium inorganic suspended particles. In the presence of a considerable amount of suspended sand is advisable to use the hydrocyclone sand separator before.)

CORPO (BODY)	In acciaio verniciato o zincato a caldo (painted steel or hot dip galvanized steel)
ELEMENTO FILTRANTE (FILTER ELEMENT)	Rete in acciaio inox standard da 120 mesh (125 micron) (Stainless steel screen standard 120 mesh (125 micron))
PRESSIONE D'ESERCIZIO MASSIMA (MAX WORKING PRESSURE)	8 bar

PERDITE DI CARICO IN ZONA DI LAVORO SERIE TURBOVORTEX (FLOW RESISTANCE IN WORK AREA TURBOVORTEX SERIES)

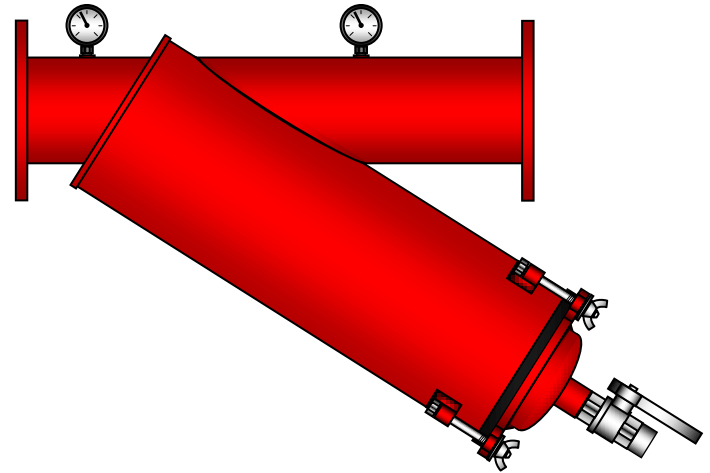
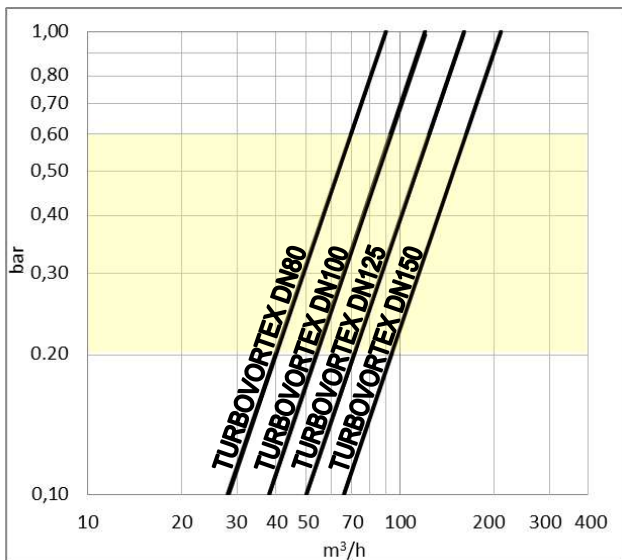

CARATTERISTICHE E DIMENSIONI

characteristics and dimensions

Modello (Model) TURBOVORTEX	DN80	DN100	DN125	DN150
Ø Ingresso/Uscita (Inlet/Outlet) (inch)	3"	4"	5"	6"
PESO (weight) (kg)	28	30	35	42
PORTATA (flow rate) (m³/h)	28 - 90	38 - 120	50 - 160	66 - 210
AREA FILTRANTE (filtration area) (cm²)	2000	2650	3300	3950
ØG (inch)	DN80	DN100	DN125	DN150
A (mm)	700	880	940	1025
B (mm)	500	560	630	680
C (mm)	700	800	900	1000
D (mm)	273	273	273	273
E (mm)	655	720	770	820
F (mm)	450	550	650	750
IMBALLAGGIO (packaging) (m³)	0.26	0.26	0.26	0.26

