

Filtro a Circolazione 'CSF' (Circulating Screen Filter 'CSF')

Il filtro a circolazione viene impiegato per filtrare acqua proveniente da pozzo, lago, fiume, etc. con piccole e medie particelle inorganiche in sospensione. In presenza di una notevole quantità di sabbia in sospensione è consigliabile usare prima il separatore di sabbia.

(The circulating screen filter is suitable to filter water from a well, lake, river, etc. with small and medium inorganic suspended particles. In the presence of a considerable amount of suspended sand is advisable to use the hydrocyclone sand separator before.)

CORPO (BODY)	In acciaio verniciato o zincato a caldo (painted steel or hot dip galvanized steel)
ELEMENTO FILTRANTE (FILTER ELEMENT)	Cartuccia e rete in acciaio inox da 120 mesh (125 micron) (Stainless steel cartridge and screen 120 mesh (125 micron))
PRESSIONE D'ESERCIZIO MASSIMA (MAX WORKING PRESSURE)	8 bar

PERDITE DI CARICO IN ZONA DI LAVORO SERIE CSF (FLOW RESISTANCE IN WORK AREA CSF SERIES)

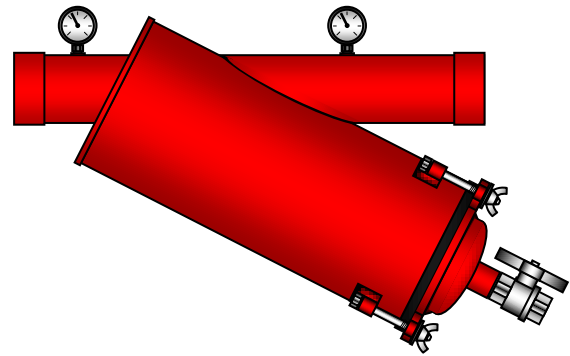
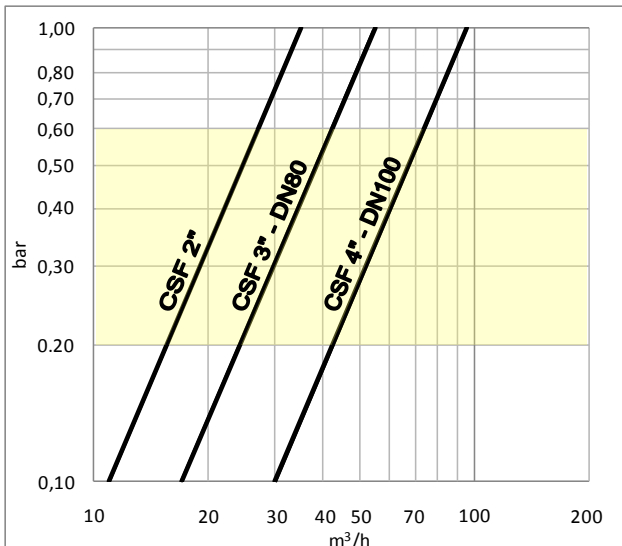

CARATTERISTICHE E DIMENSIONI

characteristics and dimensions

Modello (Model) CSF	2"	3"	DN80	4"	DN100
Ø Ingresso/Uscita (Inlet/Outlet) (inch)	2"	3"	3"	4"	4"
PESO (weight) (kg)	11.5	14	18	21	26
PORTATA (flow rate) (m³/h)	11 - 35	17 - 55	17 - 55	30 - 96	30 - 96
AREA FILTRANTE (filtration area) (cm²)	968	1407	1407	1846	1846
ØG (inch)	2"	3"	DN80	4"	DN100
A (mm)	630	720	720	820	820
B (mm)	300	410	460	480	540
C (mm)	500	610	610	880	880
D (mm)	168	168	168	219	219
E (mm)	480	625	565	770	685
F (mm)	300	400	400	500	500
IMBALLAGGIO (packaging) (m³)	0.09	0.13	0.13	0.13	0.13

